



SCHOTTKY BARRIER RECTIFIERS

FEATURES

- High current rectifier Schottky diodes
- Low voltage, low inductance
- For detection and step-up-conversion

MECHANICAL DATA

- Case: SOD-323
- Terminals: Solderable per MIL-STD-750, Method 2026
- Approx. Weight: 5.48mg / 0.00019oz

PINNING

PIN	DESCRIPTION
1	Cathode
2	Anode

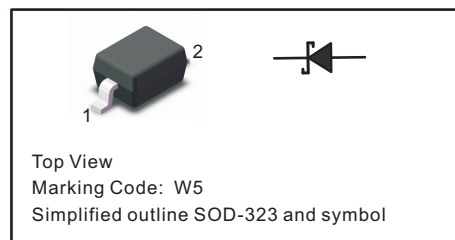

Maximum Ratings at 25 °C

Parameter	Symbols	BAT60B	Units
Non-repetitive Peak Reverse Voltage	V_{RRM}	10	V
Forward Current	I_F	3	A
Forward Surge Current at 8.3ms	I_{FSM}	20	A
Power Dissipation at $T_c=25^\circ\text{C}$	P_D	350	mW
Operating and Storage Temperature Range	T_j, T_{stg}	-55 ~ +150	$^\circ\text{C}$

ELECTRICAL CHARACTERISTICS ($T_a=25^\circ\text{C}$ unless otherwise specified)

Parameter	Symbols	BAT60B	Units
Maximum Forward Voltage $I_F=10\text{ mA}$ $I_F=100\text{ mA}$ $I_F=500\text{ mA}$ $I_F=1000\text{ mA}$	V_F	0.30 0.38 0.50 0.60	V
Peak Reverse Current $V_{R1}=5\text{V}$ $V_{R2}=8\text{V}$	I_R	15 20	μA
Diodes Capacitance $V_R=5\text{V}, f=1\text{MHz}$	C_T	30	pF



Fig.1 Power Derating Curve

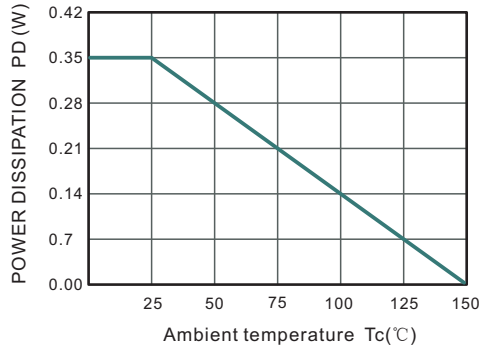

Fig.2 Typical Reverse Characteristics

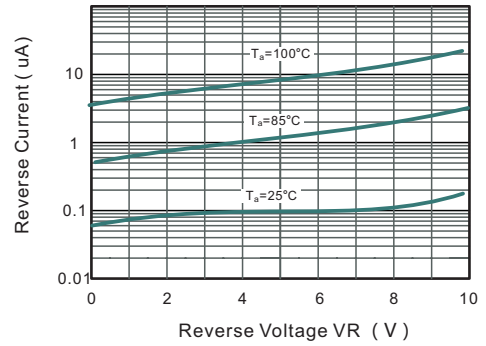

Fig.3 Typical Junction Capacitance

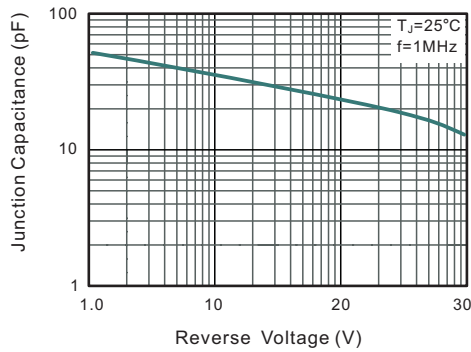

Fig.4 Typical Forward Characteristic

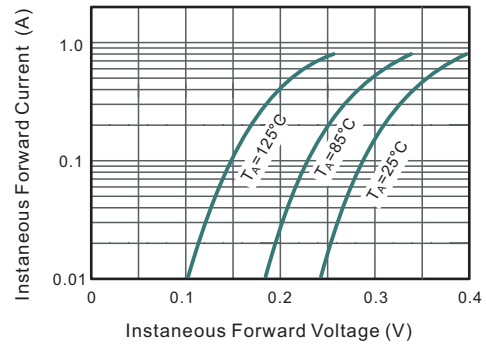
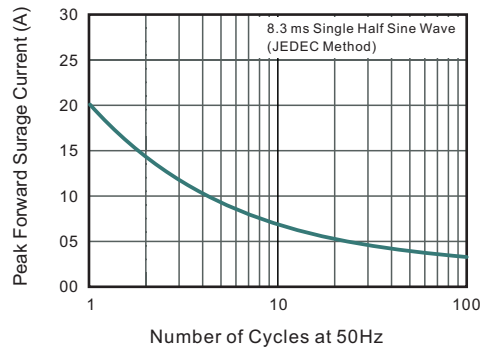

Fig.5 Maximum Non-Repetitive Peak Forward Surge Current





PACKAGE OUTLINE

Plastic surface mounted package; 2 leads

SOD-323

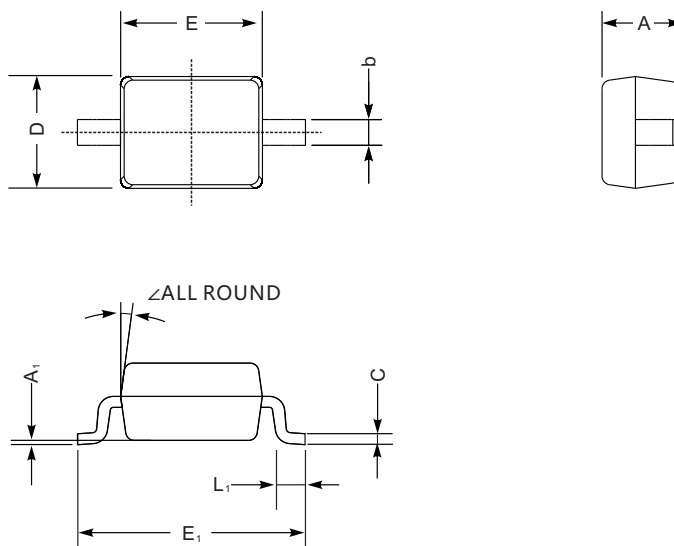

SOD-323 mechanical data

UNIT		A	C	D	E	E ₁	b	L ₁	A ₁	∠
mm	max	1.1	0.15	1.4	1.8	2.75	0.4	0.45	0.2	9°
	min	0.8	0.08	1.2	1.4	2.55	0.25	0.2	—	
mil	max	43	5.9	55	70	108	16	16	8	
	min	32	3.1	47	63	100	9.8	7.9	—	

The recommended mounting pad size

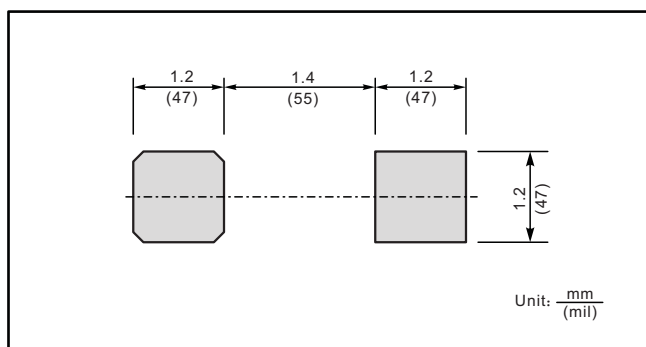

Marking

Type number	Marking code
BAT60B	W5